

Blue Line Gen2
**Pet Friendly TriTech
 Motion Detector**
 ISC-BDL2-WP12, ISC-BDL2-WP6

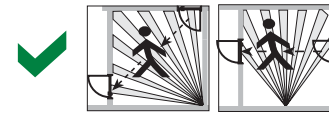

2,2 m - 2,75 m
 (7.5 ft - 9 ft)
 Recommended:
 2,2m (7.5 ft)

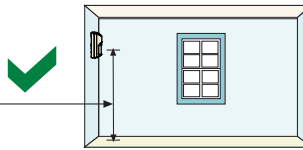

Pet Friendly
 ≤ 45 kg (100 lb)

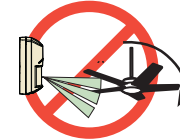
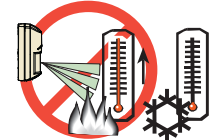
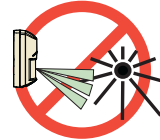
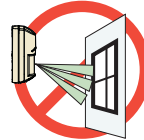

en Installation Guide

This product is intended for use in the following countries within the European Union and in other countries outside of the European Union:

ISC-BDL2-WP12G, ISC-BDL2-WP6G (10.525 GHz):
 Austria, Belgium, Denmark, Finland, Greece, Italy, Luxembourg, Netherlands, Norway, Portugal, Spain, Sweden

ISC-BDL2-WP12H (10.588 GHz):
 France, United Kingdom

Optional Brackets:
 B328, B338, B335

Changes or modifications not expressly approved by Bosch Security Systems, Inc. can void the user's authority to operate the equipment.

UL/C-UL
 Perform Walk Test at least once a year.
 Pet immunity not tested by UL/C-UL.
 Use only a Listed limited-power source.
 The Listed control unit or a Listed burglary power supply must provide 4 hours (40 mAh) of standby power.
 Install the unit in accordance with National Electrical Code NFPA 70 and Part 1 of the Canadian Electrical code CSA C22.1.
 Adjust the microwave range control, if necessary, to achieve maximum range.

SELV
 Connect all wiring to a safety extra-low voltage (SELV) circuit only.
CE EN 50131-2-4 Grade 2 (Non-pet Applications Only)
E EN 50130-5 Environmental Class II
 IP30 IK04 (EN 60529, EN 62262)

För svensk installationsanvisning se www.boschsecurity.se.

Ligue todas as cablagens apenas a um circuito de segurança de tensão extra baixa (SELV).

Conecte el cableado únicamente a un circuito de seguridad para voltajes muy bajos (SELV).

Alle Drähte sind ohne Ausnahme an Niederspannung anzuschließen.

INCERT B-509-0052/b

NF Certificats NF A2P
 2820200003-B0 (WP12H)
B2D 2820200003-D0 (WP12G)
 2820200003-E0 (WP6G)
 2 boucliers NF324 - H58
 Autosurveillance à l'ouverture
 Immunité champ magnétique
 Test sans masque de vision verticale
 et sans immunité aux animaux
www.afnor.org
www.cnpp.com

Sluit alle bedrading uitsluitend aan op een circuit met een extra lage veiligheidsspanning.

Prenez soin de connecter tous les câbles à un circuit à très basse tension de sécurité (TBTS).

Collegare tutti i cavi esclusivamente a un circuito SELV (circuito di sicurezza a bassissima tensione).

-30°C to +55°C
 (-20°F to +130°F)
 UL/C-UL Listed
 installations,
 the temperature range
 is 0°C to +49°C
 (+32°F to +120°F)



Pour les installations
 certifiées NFA2P,
 Température de
 fonctionnement
 -10°C à +55°C



0 - 95% Relative Humidity
 (0 - 85% UL/C-UL installations)

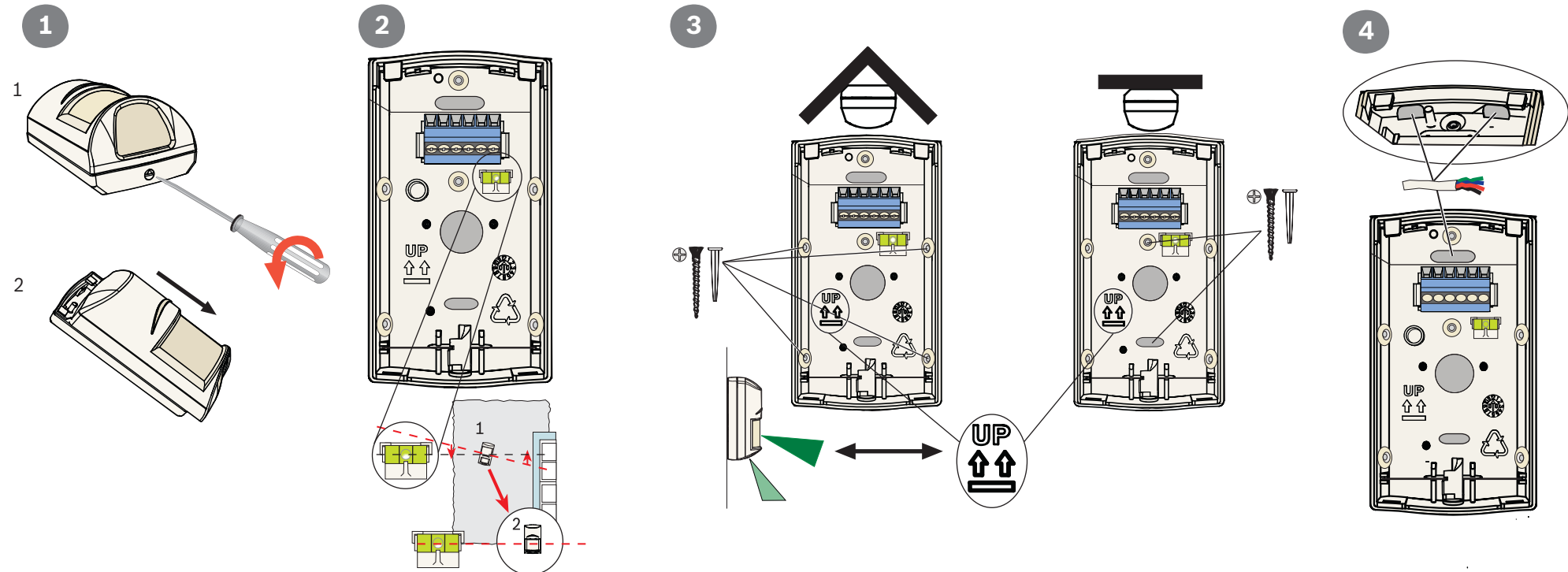

5

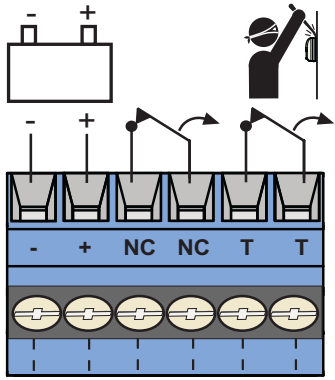

9 - 15 VDC ≤ 100 mA, 25 VDC, 2.5 W
 10 mA (0.12W) @ 12 VDC $< 20 \Omega$ closed



9-15 Vcc
 de 7 à 9 mA @ 12 Vcc en veille/
 en alarme, source limitée en
 puissance, ondulation
 résiduelle 1 V.

6

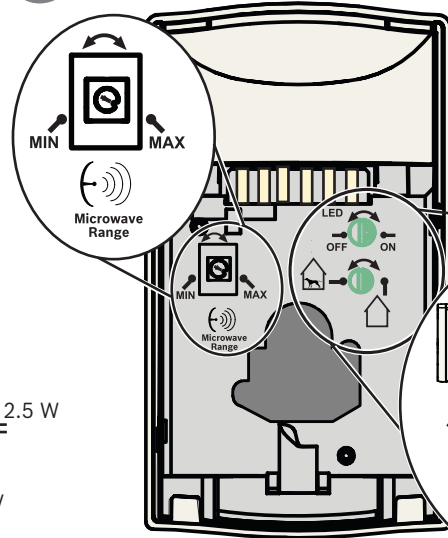

7

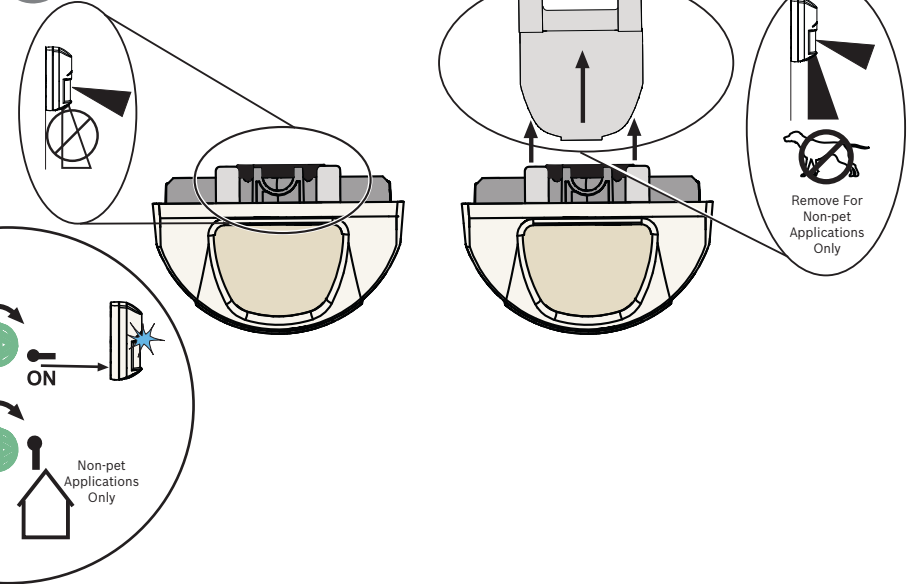

8

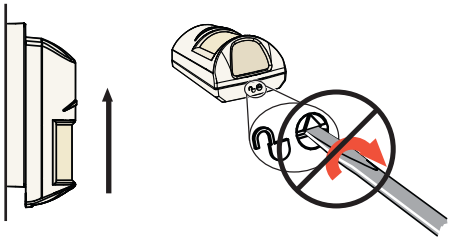

9



10

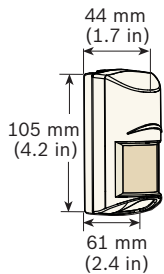
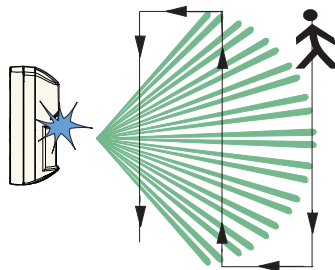

? → www.boschsecurity.com

Reading Bosch Security Systems, Inc. Product Date Codes
 For Product Date Code information, refer to the
 Bosch Security Systems, Inc. Web site at:
<http://www.boschsecurity.com/datecodes/>.

